

AMPLION DELEGATE HU610

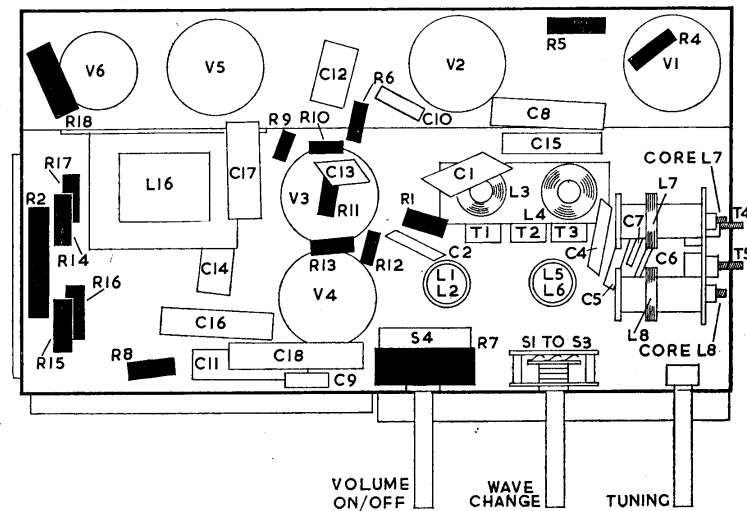
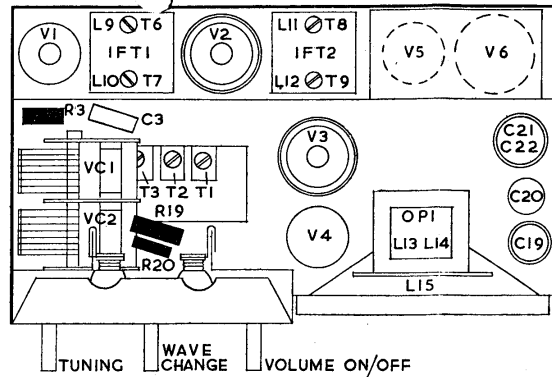
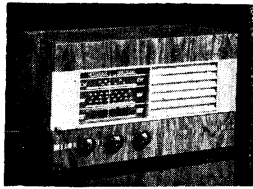

RESISTORS

R	Ohms	Watts	R	Ohms	Watts	R	Ohms	Watts
1	4.7K	1/4W	8	12 meg	1/4W	15	22K	1/4W
2	25K	1/4W	9	100K	1/4W	16	180	1/4W
3	470K	1/4W	10	1 meg	1/4W	17	33	1/4W
4	56K	1/4W	11	3.3 meg	1/4W	18	50	1/4W
5	22K	1/4W	12	180K	1/4W	19	50	1/4W
6	56K	1/4W	13	56K	1/4W	20	220	1/4W
7	500K Potentiometer with SP Switch		14	22K	1/4W			

Five-valve, three-waveband table superhet for operation on 110 to 250 volts AC/DC mains. Fitted with permanently attached "throwout" type aerial. In walnut veneer cabinet. Manufactured by Amplion (1932) Ltd., 230, Tottenham Court Road, London, W1.

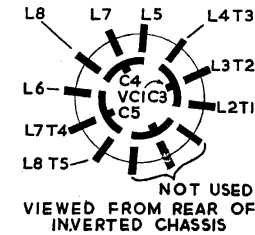
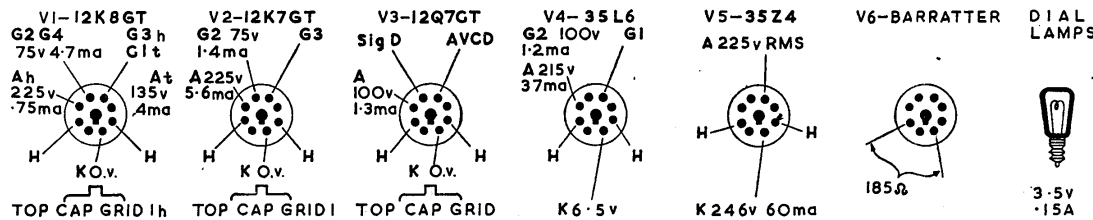

CAPACITORS

C	Mfds	Type
1	500pF	Silver Mica
2	2000pF	Silver Mica
3	100pF	Mica
4	50pF	Silver Mica
5	50pF	Silver Mica
6	300pF	Silver Mica
7	150pF	Silver Mica
8	.1	Tubular 350V
9	100pF	Mica
10	100pF	Mica
11	.01	Tubular 1000V
12	50pF	Silver Mica
13	500pF	Mica
14	.01	Tubular 1000V
15	.01	Tubular 1000V
16	.01	Tubular 1000V
17	.05	Tubular 500V
18	.1	Tubular 350V
19	4	Electrolytic 350V
20	25	Electrolytic 25V
21	12	Electrolytic 350V
22	12	Electrolytic 350V

INDUCTORS

L	Ohms
1	15
2	Very Low
3	2.5
4	11.5
5	22
6	Very Low
7	3.25
8	7.25
9	2.25
10	2.25
11	1.8
12	1.8
13	280
14	4
15	2.5
16	250

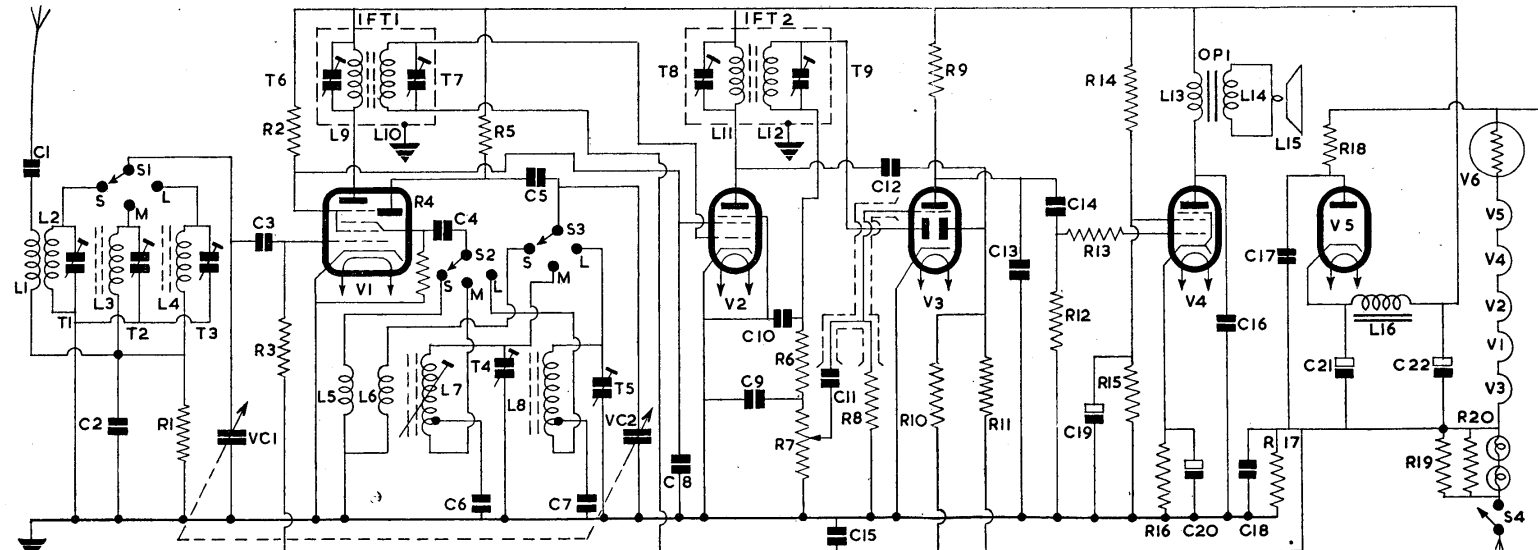

AMPLION DELEGATE
HUGIO—Continued

CIRCUIT consists of a triode-hexode frequency changer V1 coupled by a capacity-tuned iron dust core transformer to the IF amplifier V2, a variable-mu RF pentode. A second capacity-tuned iron core transformer couples V2 to a double-diode triode V3 which provides signal rectification, AVC and AF amplification. V3 is resistance-capacity coupled to the pentode output valve V4. Output from V4 is fed to a 5-in. PM speaker. High tension is provided, on AC mains, from an indirectly heated half-wave rectifier V5. A barretter V6 provides a regulated current for the valve heaters on 200-250 volt mains supplies. On 110 volt working V6 needs to be shorted out.

Aerial, consisting of approximately 36 ft. of insulated wire, is coupled through C1 to the SW aerial coupling coil L1 and to bottom ends of tuned coils L3 (MW), L4 (LW). R1, C2, are components associated with bottom end coupling used on MW and LW bands. S1 connects tuned circuits L2 (SW), L3 (MW), and L4 (LW), to aerial tuning capacitor VC1 and through C3 to grid of V1. T1, T2, T3 are aerial trimmers. Cathode of V1 is connected to chassis. AVC and a small standing bias is fed to grid through R3.

Screen voltage is obtained from R2 decoupled by C8. L9, T6, forming the primary of IFT1, are in the anode circuit of V1.

Oscillator is connected in a tuned-anode parallel fed HT circuit. L6 (SW), L7 (MW), and L8 (LW), are the tuned coils switched by S3 to oscillator tuning capacitor VC2 and through C5 to anode of triode oscillator portion of V1. T4, T5 are MW and LW, trimmers and C6, C7, padders. No trimmer or padder is provided for the SW range. R5 is oscillator anode load. S2 switches reaction voltages, developed on L6 (SW) and on portion of L7, L8 for MW and LW bands, to oscillator grid through C4. R4, C4 provide leak-condenser bias for grid.

IF Amplifier operates at 465 kc/s. L10, T7, the secondary of IFT1, applies signal to grid of IF amplifier V2. Cathode is at chassis potential and a small standing bias, together with AVC voltage is fed to grid from R10, decoupled by C15. Screen voltage is obtained from R2 decoupled by C8, L11, T8, forming the primary of IFT2, are in the anode circuit.

Signal Rectifier. L12, T9, the secondary of IFT2, applies signal to one diode of V3. R7, the volume control, is the detector diode load and R6, C9, C10 form an IF filter.

Automatic Volume Control. C12 feeds signal at anode V2 to second diode of V3. R11 is the diode load. Bottom end of R11 is connected to R17, in the HT negative lead to chassis, to provide a delay voltage for the AVC diode. The cathode of V3 is at chassis potential. R10, C15 provide AVC line decoupling.

AF Amplifier. C11 feeds signal from volume control R7 to grid of triode section V3. R8 is grid resistor and bias for triode grid is developed on C11. R9 is the anode load and C13 anode bypass.

Output Stage. C14 feeds signal at anode V3 to grid of pentode output valve V4 through grid

stopper R13. R12 is grid resistor. Cathode bias is provided by R16 decoupled by C20. Screen voltage is obtained from potential dividing network R14 and R15 decoupled by C19.

L13, the primary of OP1, the output matching transformer, is in the anode circuit of V4. C16 prevents rise in impedance of L13 at high frequencies. L14, the secondary of OP1, feeds into speech coil L15 of the 5-in. PM loudspeaker.

High Tension is provided on AC supplies by an indirectly heated half-wave rectifier V5. Its anode voltage is obtained from the mains supply and is fed to anode through limiter R18. C17 is fitted to eliminate modulation hum. R17, decoupled by C18, connected in the HT negative return to chassis provides delay bias for AVC line and standing bias for grids of V1 and V2. In some earlier models of this receiver bias is also fed to triode grid of V3. In these sets, R8 is connected to top of R17 instead of the chassis. L16, C21, C22 provide choke-capacity smoothing of the HT supply.

Heaters of V1 to V5 and the two dial lamps are connected in series and obtain their current, on 200/250V mains supply, through regulating barretter V6. When 110V mains supply is used, V6 is removed and pins 2 and 8 of its valve holder are shorted. Dial lamps are shunted by R19 and R20. S4, ganged to the volume control, is the ON/OFF switch.

Removal of chassis from cabinet. Remove three control knobs and rear panel of cabinet. Remove single chassis bolt on underside of case and the two wood screws fastening ends of chassis to wood slat at either side of back of cabinet. Withdraw chassis carefully, tilting it to give clearance for the top of dial plate assembly. Unsolder lead from sub-chassis wiring where it is joined to aerial lead.

TRIMMING INSTRUCTIONS

Apply signal as stated below	Tune Receiver to	Trim in Order stated for Max. Output
(1) 465 kc/s to top cap V1 via .01 capacitor	—	T9, T8, T7, T6.
(2) 150 kc/s to AE lead via dummy aerial	2000 metres	Core L8
(3) 300 kc/s as above..	1000 metres	T5, T3. Repeat (2) and (3)
(4) 600 kc/s as above..	500 metres	Core L7
(5) 1.5 mc/s as above..	200 metres	T4, T2. Repeat (4) and (5)
(6) 12 mc/s as above..	25 metres	T1

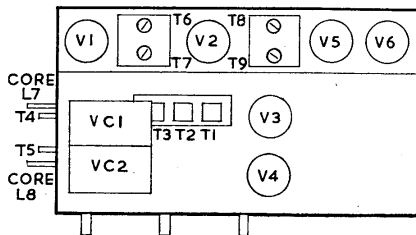

Under control..

WHEN it is a question of indicating or recording instruments, electrical engineers everywhere think of Everett Edgcombe.

Right from the days when the electrical industry was in its infancy, Everett Edgcombe established a lead in this field—a leadership which they still hold to-day.

This fact is the reward of nearly fifty years of faithful and outstanding service to industry.

EVERETT EDGCOMBE

Makers of electrical instruments for indicating, recording and controlling, photometric apparatus and process controls.

COLINDALE WORKS, LONDON, N.W.9. Tel.: COLindale 6045

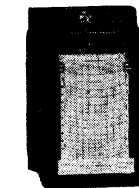

"Inkwell" Switchboard Graphers

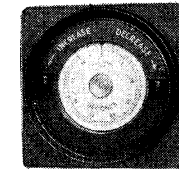

Process Timers

STAND C7, OLYMPIA, B.I.F., May 3rd to 14th

DHB

it's amazing
ON RADIO CABINETS!



Nett Trade Price, at all Wholesalers.

1 1/2 PER TIN

Manufactured by: **SERVISOL LTD.** Head Office: 14, North John St., Liverpool, 2.

Made with Carnauba-Hard-wax, especially for Cellulose Cabinets, gives brilliant hard gloss. Eliminates Scratches instantly. The Radio Engineers' Friend.